



BEISSEL
NEEDLE FOR ALL NEEDS

THE WHOLE STORY
ABOUT PARTS
OF A NEEDLE

To the naked eye, a needle looks like a tiny piece of metal. Take a closer look and you will be amazed at the 20 odd parts that make up this magical fashion tool. Attached are illustrations of the needle with proper labeling to help you study the parts.

PARTS OF A NEEDLE

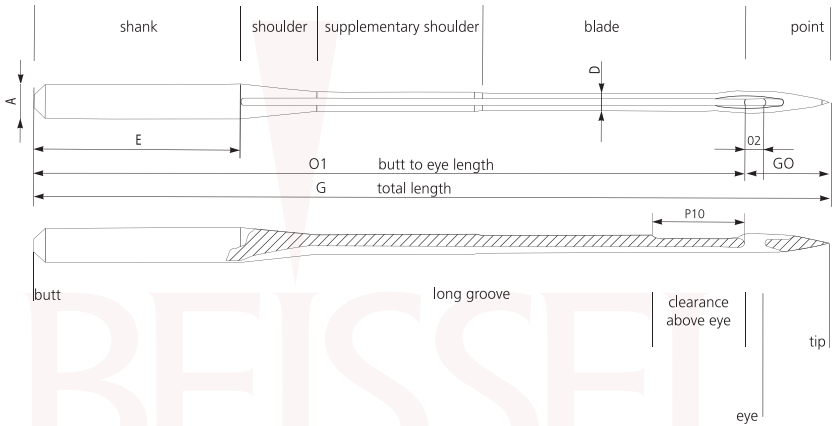

PARTS OF A NEEDLE

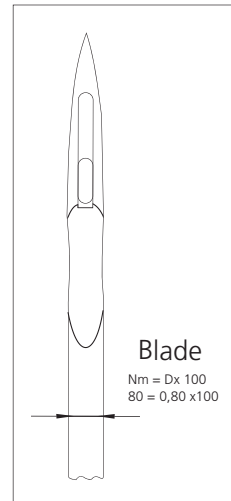
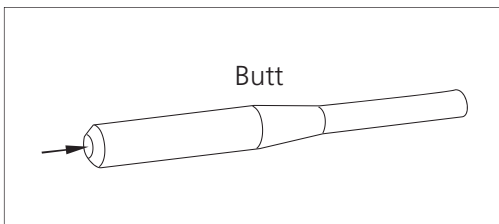
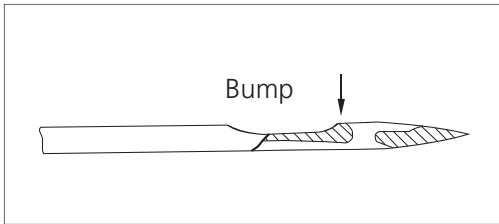

PARTS OF A NEEDLE

Butt to eye length

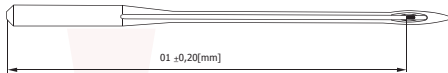

CAE Depth

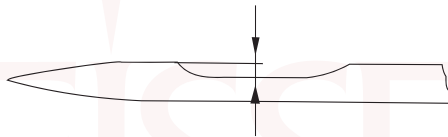

Eccentric tip



Eye length and width

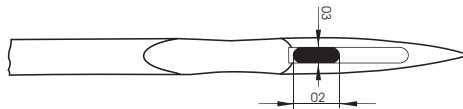

PARTS OF A NEEDLE

Shank thickness

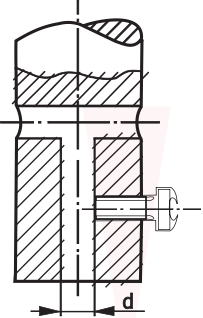

d (mm)	Tolerances (mm)	
1.64	+0.006	+0.020
2.00	+0.006	+0.020

German

d (mm)	Tolerances (mm)	
1.64	+0.000	+0.050
2.00	+0.010	+0.050

Japanese

Shank thickness

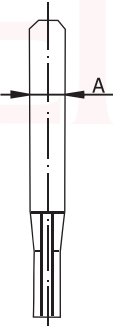

A (mm)	Tolerances (mm)	
<1	+0,020	-0,020
1-3	+0,000	-0,025
>3	+0,000	-0,030

German

A (mm)	Tolerances (mm)	
1,64	+0,030	-0,030
2,02	+0,030	-0,030

Japanese

Notched shank

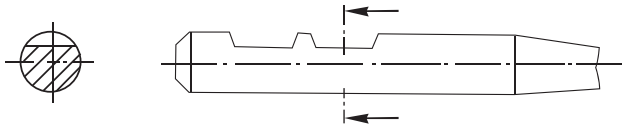

PARTS OF A NEEDLE

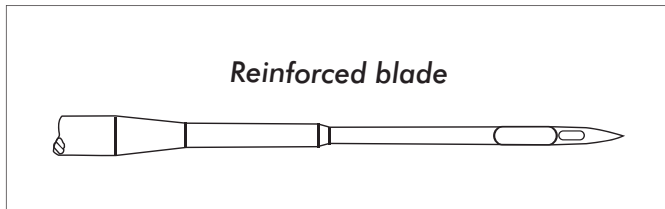
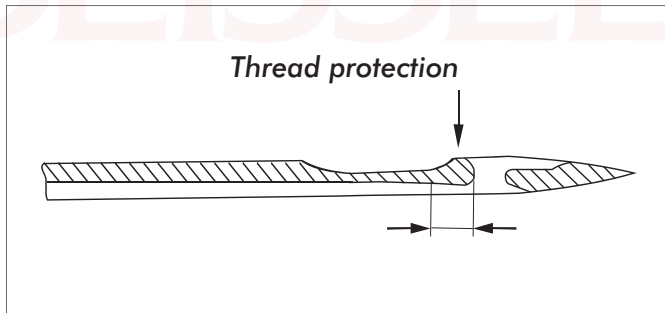
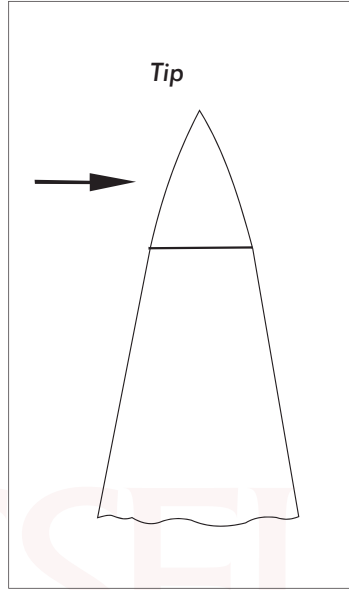
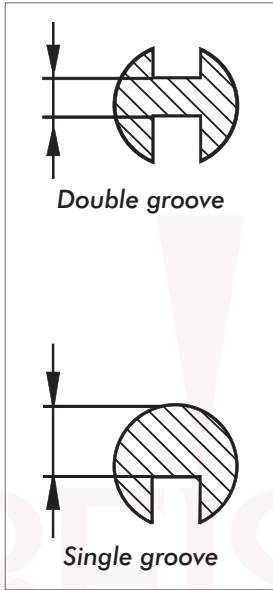

PARTS OF A NEEDLE

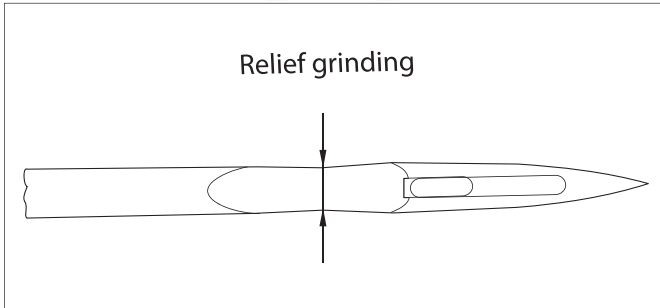
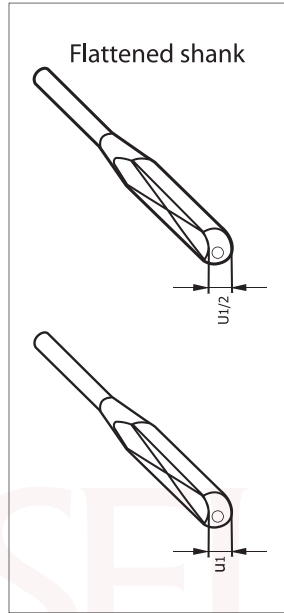
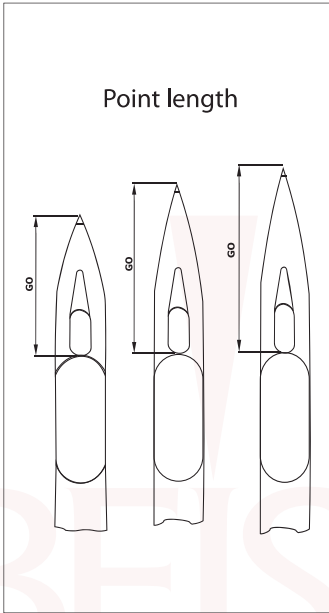

CUTTING POINTS

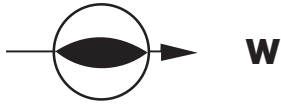

Narrow Wedge Point (P)

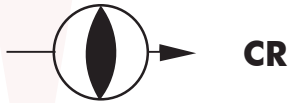

Cross Point (S)



Twist Point (LL)

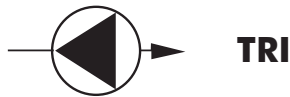

Triangular Point (LL)

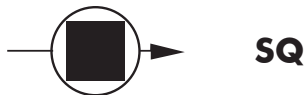

Square Point (Q)



Reverse Twist Point (LR)

ROUND POINTS

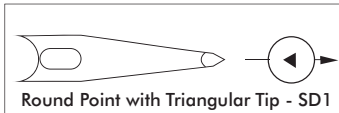
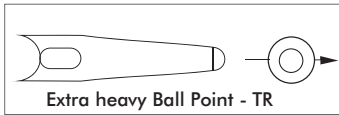
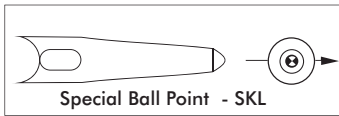
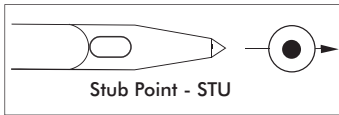
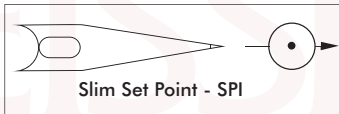
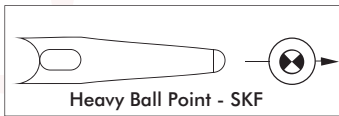
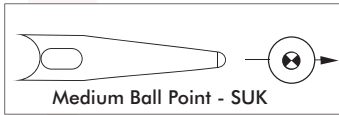
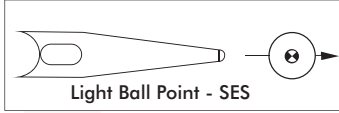

Beissel is trusted by the biggest and the best
– in India and 44 countries around the world



Significant cost savings



Quality trusted by leading customers



Exported to all continents



155 quality checks on every needle



Conforms to German DIN standards



Training support and customer care



Useful resources available online



Altek Beissel Needles Limited

3/27, Vandalur Road, Kelambakkam, Kanchipuram District, Tamil Nadu 603 103, India

Phone: (044) 2747 4374, 2747 4832/33, 6745 6488/89 | Fax: (044) 2747 4316

Email: info@beisselneedles.com | Web: www.beisselneedles.com